

TABLE 1: BE-8XXC(NPL) CAMERA KIT OPTIONS

PART NO.	MODEL NO.	DESCRIPTION
5976A	BE-800C(NPL)	CAMERA, ELITE, HEATED, ULTRA-LOW-LIGHT, PAL, NO BRANDING
5979A	BE-850C(NPL)	CAMERA, ELITE, HEATED, ULTRA-LOW-LIGHT, PAL, 12-24VDC, NO BRANDING
5766	BE-850C(78)(NPL)	CAMERA, ELITE, HEATED, ULTRA-LOW-LIGHT, PAL, 12-24VDC, 78", NO BRANDING

CHANGES FROM BASE PRODUCT BE-8XXC TO BE-8XXC(NPL)

CHANGE:

1. BE-8XXC-C REPLACED WITH BE-8XXC(C)(NPL)
2. BE-8XXC G8-LBL REPLACED WITH BE-8XXC(NPL) G8-LBL.
3. BE-8XXC BE-2XXC-I(6) (3247C) REPLACED WITH BE-8XXC-I(G)(NPL) (5981A).

OPERATION:

1. SAME AS BASE PRODUCT

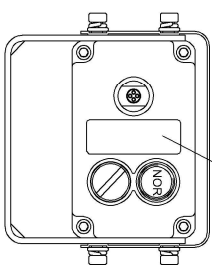
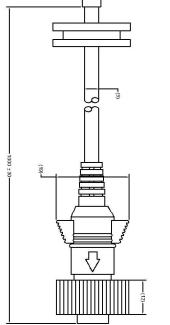
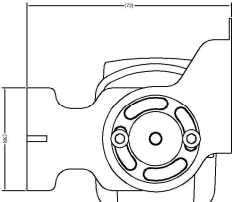
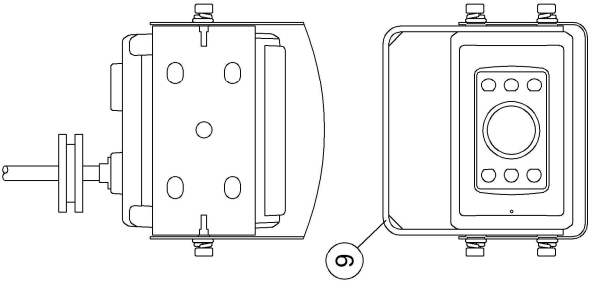
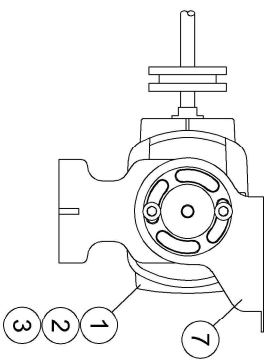
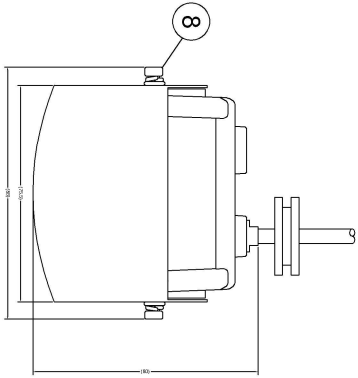

VIEW A

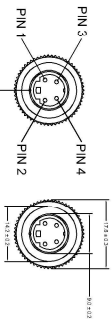

4 PIN MINI DIN MALE MATING FACE

PIN #	WIRE COLOUR	DESCRIPTION
1	YELLOW	VIDEO
2	RED	+12V
3	BLUE	N.C
4	WHITE	AUDIO
5	BLACK/SHIELD	GND

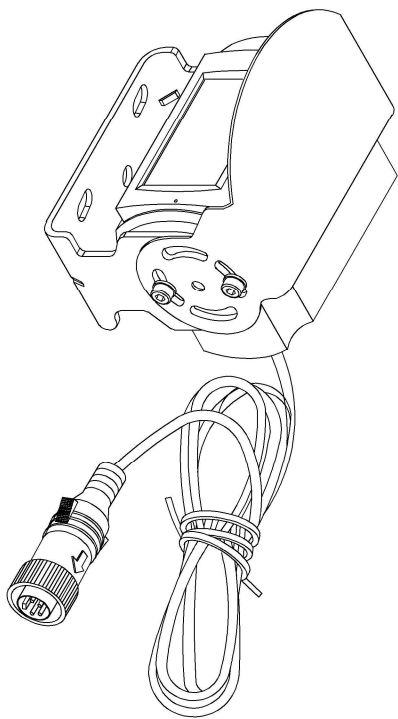

TABLE 2: CAMERA KIT CONTENTS

ITEM	PART NO.	QTY.	DESCRIPTION
①	5977A	1	CAMERA, HEATED, PAL, NO BRANDING
②	5979A	1	CAMERA, HEATED, PAL, 12-24VDC, NO BRANDING
③	5767	1	CAMERA, HEATED, PAL, 12-24VDC, 78", NO BRANDING
④	5981	1	INSTALLATION GUIDE (NOT SHOWN)
⑤	5981A	1	INSTALLATION GUIDE (NOT SHOWN)
⑥	3244A	1	BE-8XXC BE2 XXC SERIES BRACKET
⑦	3245	1	BE-8XXC BE2 XXC SERIES SUNSHIELD
⑧	3246	1	BE-8XXC BE2 XXC SERIES FIXING KIT

NOTES:

1. REFER TO COMPONENT DRAWINGS FOR COMPONENT DETAILS.
2. FOR PRODUCT LABEL AND PACKAGING DETAILS REFER TO MASTER BOM.
3. FOR INSTALLATION DETAILS REFER TO INSTALLATION GUIDE.

PROPRIETARY NOTICE

THIS DESIGN AND TECHNICAL INFORMATION APPEARING ON THIS DRAWING IS THE PROPERTY OF BRIGADE ELECTRONICS, AND IS DISCLOSED IN CONFIDENCE. IT IS NOT TO BE COPIED, REPRODUCED, REVEALED TO OR EXPLOITED BY OTHERS, EITHER IN WHOLE OR IN PART WITHOUT THE EXPRESS WRITTEN CONSENT OF BRIGADE ELECTRONICS.

Revision Notes			
RT -	Drawn:-	Checked:-	Approved:-
APAs -			



Assembly Pl Approval		Approved by		Checked by		Drawn by	
TCH01		B CHILDS		S GOVENDER		J TYRRELL	
Angle of Projection	Third Angle	Units	Scale	Released	Assembly Ref	Status	Part No
		mm	N/A	21/09/20		RELEASED	BE-004,430-00-20